

PANEL_01

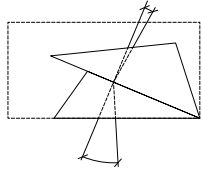

PANEL_02

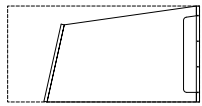

PANEL_03

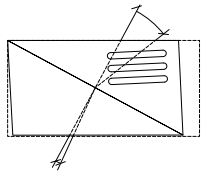

PANEL_04

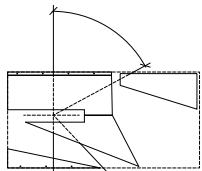

PANEL_05
PANEL TEMPLATE

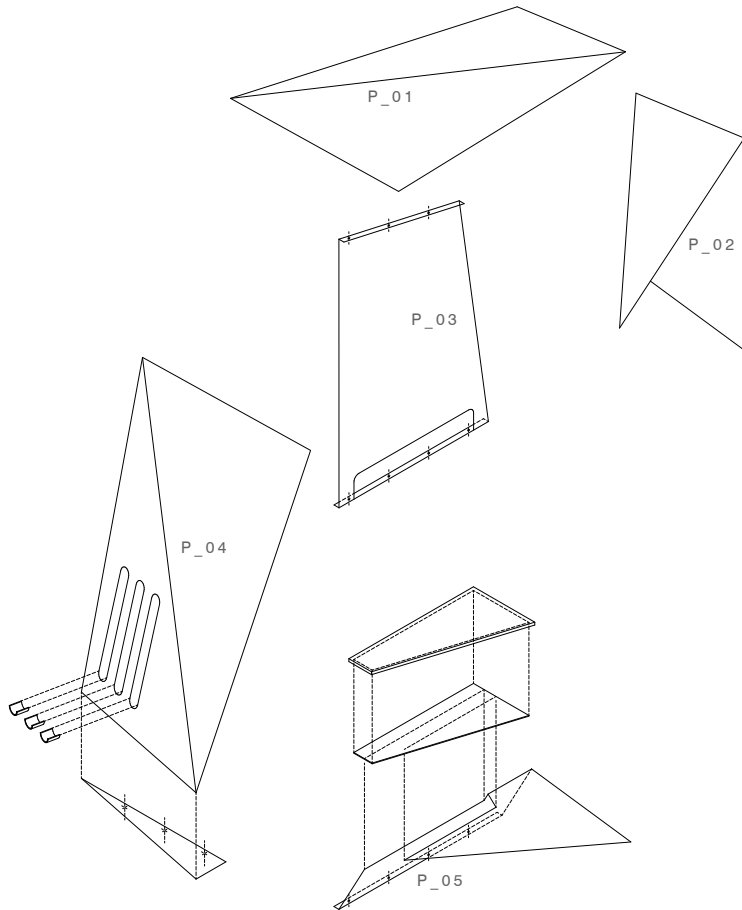

EXPLODED AXONOMETRIC

FABRICATION AND ASSEMBLY DIAGRAM STUDY

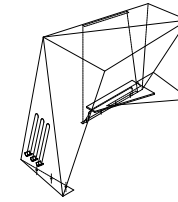

ZERO STORAGE OPTION

- SINGLE UNIT FABRICATED AND SHIPPED TO SITE ON SHORT ORDER
- WELDED ATTACHMENTS
- MOST ROBUST

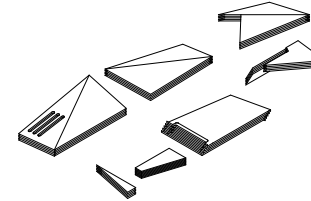

PARTS STORAGE OPTION

- PARTS FABRICATED AND SHIPPED TO CITY AGENCY FOR INSTALLATION
- NESTED COMPONENTS TO LIMIT STORAGE
- MECHANICAL ATTACHMENTS
- MOST FLEXIBLE

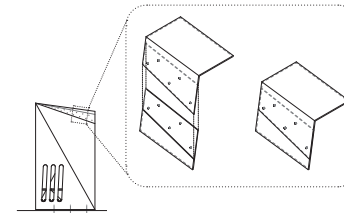

MECHANICAL ATTACHMENT DIAGRAM

- WORK WITH DOT AND CITY OF RALEIGH TO DESIGN ATTACHMENTS AROUND PREFERRED MEANS AND METHODS

REPAIR/REPLACE STUDY



GO RALEIGH



GO TRIANGLE



GO CARY



GO DURHAM

BRANDING STUDY

competition
call

design

1st
shortlist

prototype fabrication

prototype
installation

public feedback

2nd
shortlist

design refinement

winner
awarded

production

1st
installation

deployment